

ASSY, DISCH PLENUM 4-WAY
AirRite TT Series
Model 236

NOTE: USE DISCHARGE DAMPER ON STATIC PRESSURE
CHART WHEN CALCULATING SYSTEM PRESSURE DROPS.

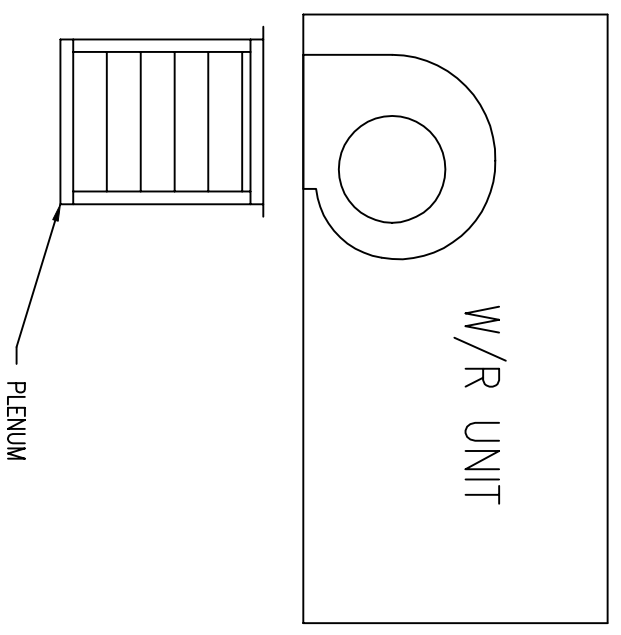
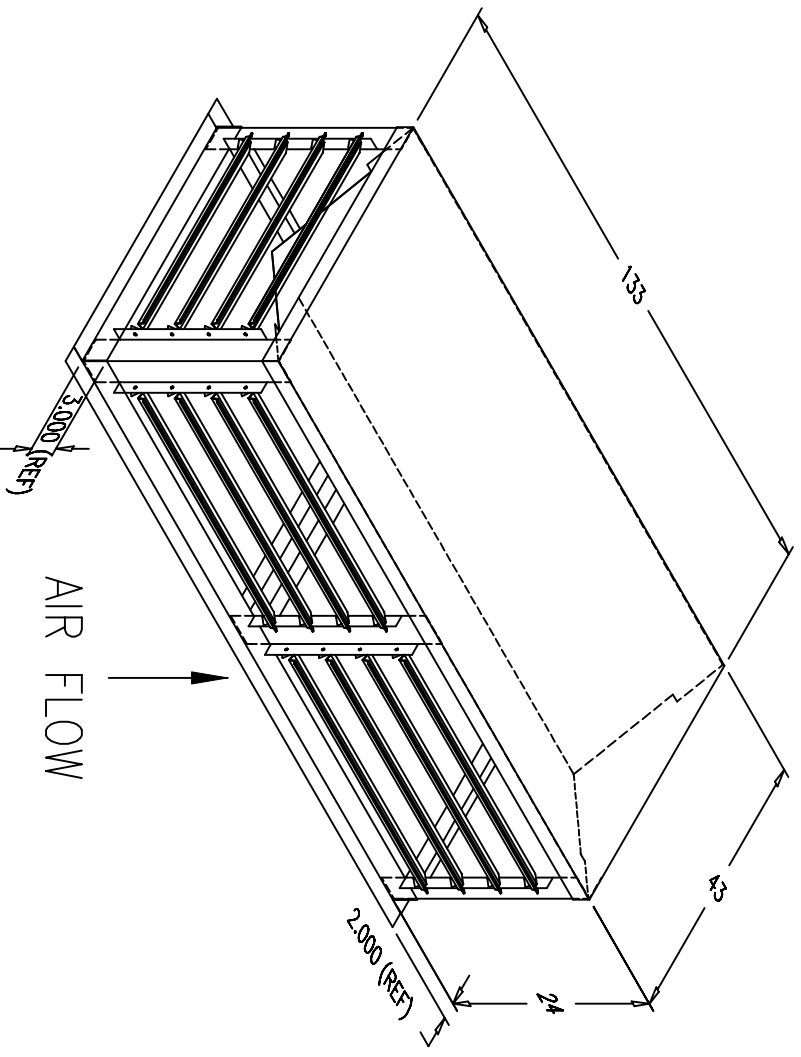

PRELIMINARY

Wentholp-Rite Inc.

NOTE:
1.) DRAWING IS NOT TO SCALE.